

MPO - 700

THE OMNIDIRECTIONAL ROBOT MPO-700 provides high-end manoeuvrability for robotic research projects. Its four independent wheels enable the MPO-700 to move along true 3D-trajectories where the robot's orientation is not constrained by its X-Y-movement.

DIFFERENT FROM OTHER KINEMATICS, the MPO-700 can drive along the front of a workbench or laboratory bench while permanently facing the workspace. This significantly improves the work-flow and reduces the danger of collisions. Furthermore the robot is capable of moving through very narrow spaces and of navigating swiftly in difficult or crowded environments.

ADDITIONAL MODULES such as manipulator arms, computers, sensors and actuators can be integrated easily to build a highly specialized and capable robotic system.

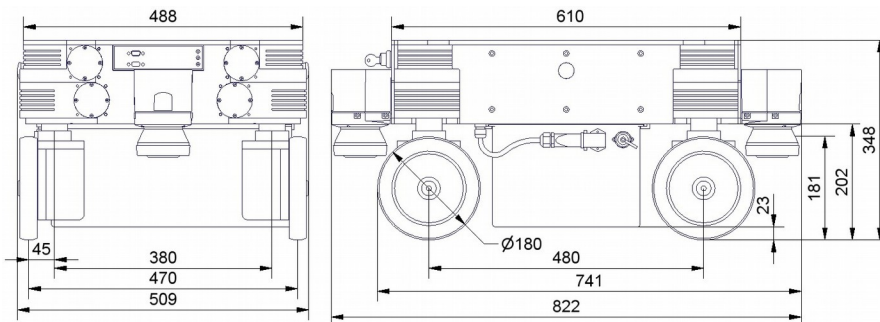

INCLUDED IN DELIVERY

- Mobile platform
- 1 x Sick S300 safety laser scanner
- Battery pack
- Wireless joystick
- Manual charger
- On-board computer
- Software package ROS
- Documentation
- CE Declaration of Conformity

OPTIONS

- Automatic charging station
- Load handling device
- 2nd laser scanner Sick S300
- Intel i7 on-board computer
- IOBoard
- Integration of robot arm
- LiFePO4 battery
- Audio system

TECHNICAL DATA

Payload	400 kg
Weight	approx. 120 kg
Ground clearance	23 mm
Speed	< 0.9 m/s
Battery pack	AGM sealed lead acid 48 V / 28 Ah
Uptime / charge time	approx. 5 h / 4 h
Sensors	Laser scanner Sick S300 Expert (optional: 2 nd laser scanner Sick S300 Expert)
Computer	Intel i5, 8 GB RAM, > 200 GB SSD, WLAN